Comfort-Cire®

Century®

PARTS LIST

**Horizontal/Side Discharge
Condensing Units**

CMA-1424SG

EXPLODED VIEW

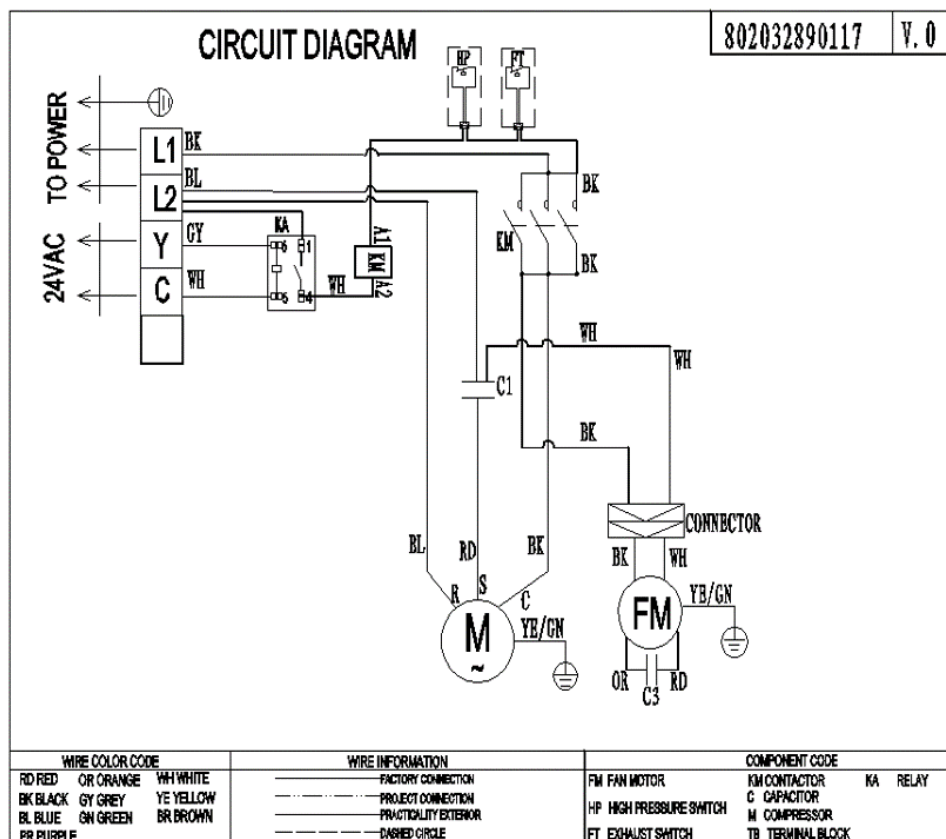
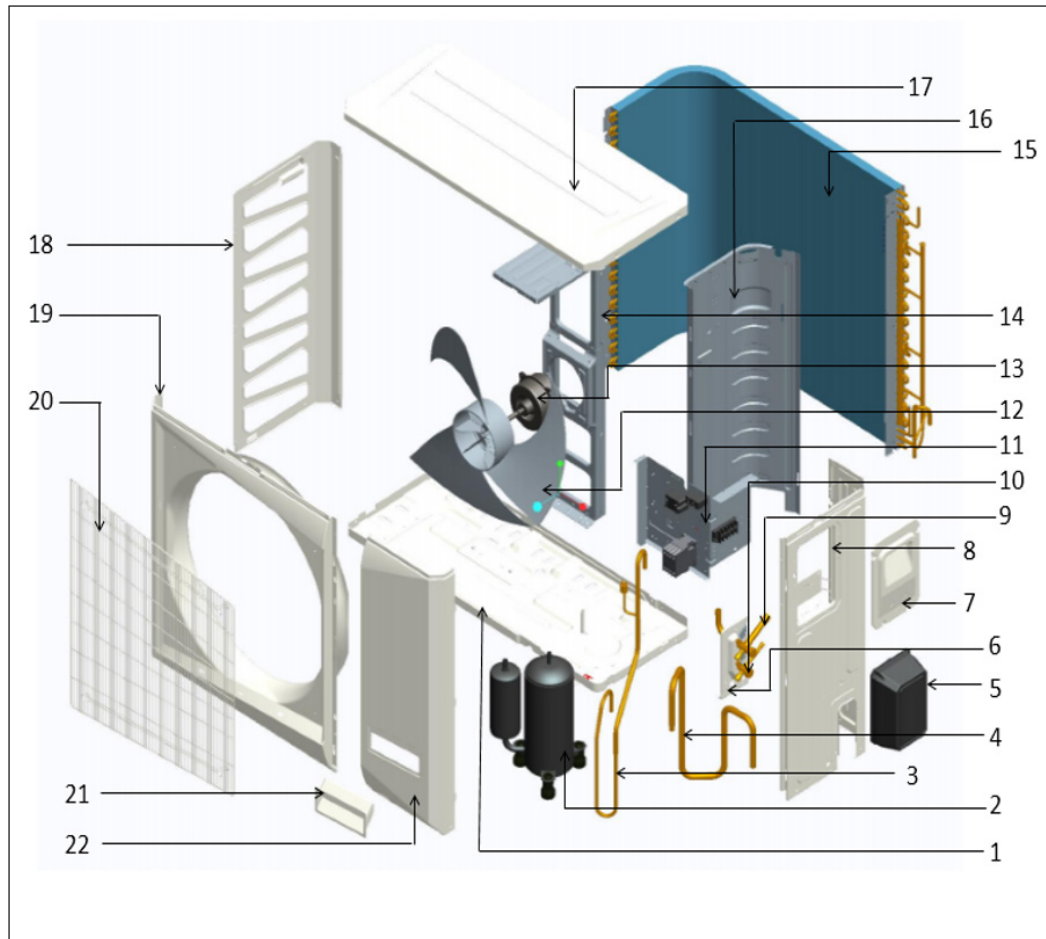

REPLACEMENT PARTS

Location	Part Name	Quantity	Part No.
1	Chassis parts	1	801232890061
2	Compressor	1	801401200008
3	Discharge pipe assy	1	801632890197
3.1	Discharge pipe of compressor #1	1	801632890206
3.2	Discharge pipe of compressor #2	1	801632890207
3.3	Pressure Switch	1	802300900041
3.4	Probe Copper Tube	1	801602600197
4	Air-return pipe of compressor	1	801632890198
5	Cover of cut-off valve	1	801137000005
6	Valve holder	1	801228200171
7	Handle (Large size)	1	801232890064
8	Right rear side panel part	1	801228200178
9	Cut-off valve (DN8)	1	801600200014
10	Cut-off valve (DN13)	1	801600200011
11	Electric control box components	1	803330000005
11.1	Electrical installation board	1	801232890059
11.2	Relay	1	8023001A0001
11.3	Compressor capacitor	1	802401000034
11.4	Fan motor capacitor	1	802401100075
11.5	Terminal	1	802401800085
11.6	Capacitor clip	1	801232000003
11.7	AC contactor	1	802300100251
12	Axial-flow fan blade	1	801100300036
13	Outdoor fan motor	1	802400400780
14	Holder of fan motor	1	801228200145
15	Condenser parts	1	801532890044
16	Separating board	1	801232890066
17	Top cover parts	1	801232890063
18	Left side panel	1	801228200177
19	Front panel	1	801228200179
20	Net cover of air outlet(Mental)	1	802932890001
21	Handle (Small size)	1	801132890002
22	Right front side panel	1	801228200181

Due to ongoing product improvements, specifications and dimensions are subject to change and correction without notice or incurring obligations. Determining the application and suitability for use of any product is the responsibility of the installer. Additionally, the installer is responsible for verifying dimensional data on the actual product prior to beginning any installation preparations.

Incentive and rebate programs have precise requirements as to product performance and certification. All products meet applicable regulations in effect on date of manufacture; however, certifications are not necessarily granted for the life of a product. Therefore, it is the responsibility of the applicant to determine whether a specific model qualifies for these incentive/rebate programs.

Comfort-Aire® **Century**®

1900 Wellworth Ave., Jackson, MI 49203 • Ph. 517-787-2100 • www.marsdelivers.com

